

X-218

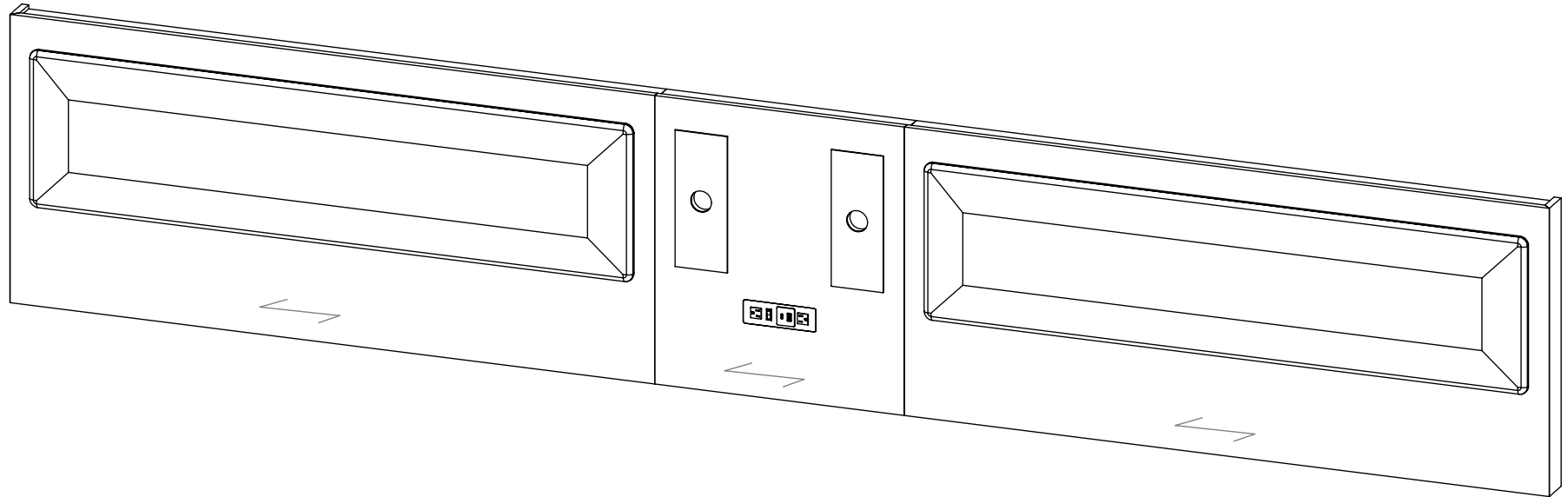

**Overall:**  
148"W x 5"D x 27 1/2"H

**MATERIALS:**

- HP-Laminate PB-5/8"
- 0.018 Edge Tape
- Plywood 1/2" Wall Cleat
- Frosted Acrylic Cover
- LED Strip 2700K-3000K
- 2/AC - 2/USB - W/Switch Plug
- 

**COMMENTS:**

- Overall: 148"W x 5"D x 27 1/2"H
- Color: Wilsonart - D504-60 - Fossil Shale  
Headboard Fabric - Per Scheme
- Note: Dimensional Tolerance +/- 1/16"

**TITLE:** AHB 8240XX H5U24N - 8250CRS - Queen HB + 24W Cntr Pnl

**REVISION DATE:**

NOTE: DESIGN AND DRAWINGS ARE PROPERTY OF DICKSON FURNITURE MANUFACTURERS LLC AND MAY NOT BE DUPLICATED OR REPRODUCED WITHOUT THE EXPRESS WRITTEN CONSENT OF DICKSON FURNITURE MANUFACTURERS LLC

REV  
**A**  
DIMENSIONS  
ARE IN  
INCHES

**DICKSON**  
FURNITURE MANUFACTURERS

SCALE: 1:15  
SHEET 1 OF 4

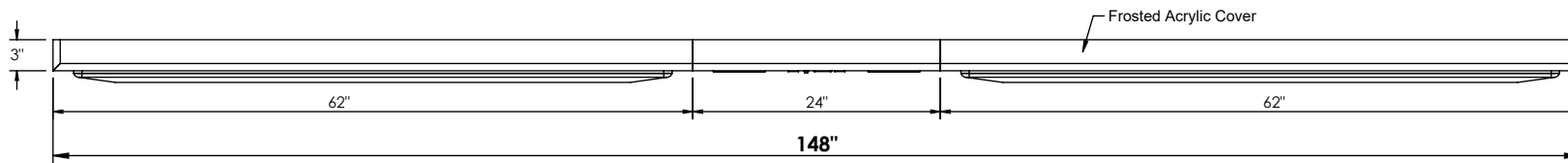

**TOP VIEW**

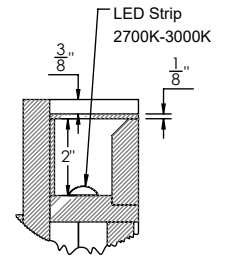

**DETAIL B**  
**SCALE 1 : 5**

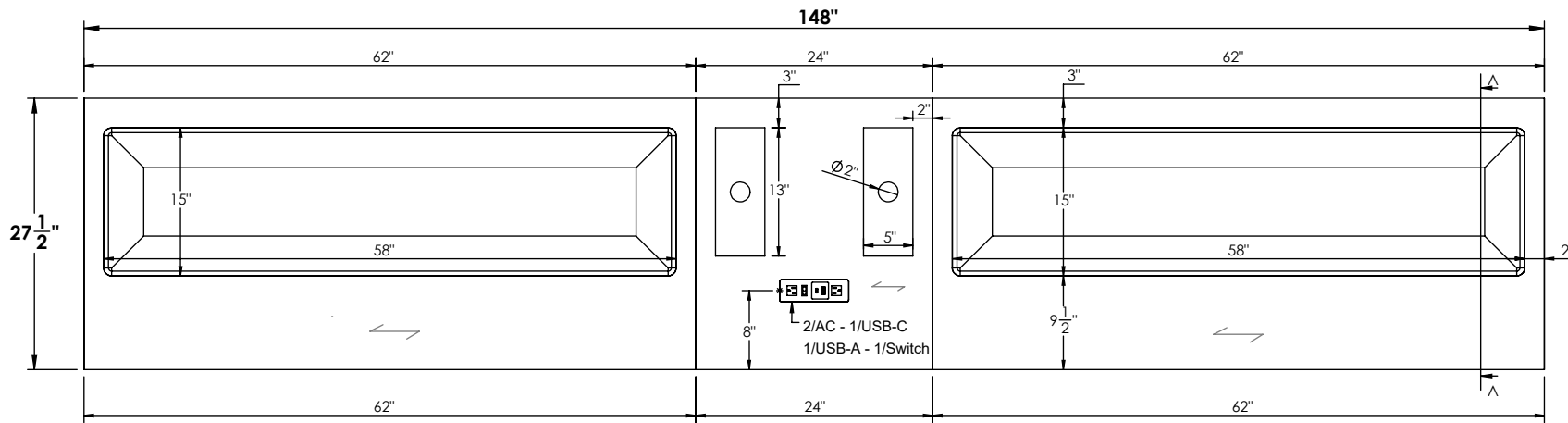

**FRONT VIEW**

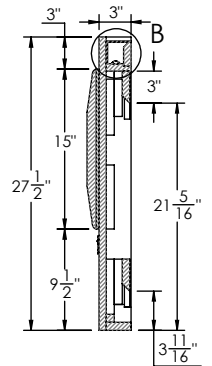

**SECTION A-A**

**MATERIALS:**  
 - HP-Laminate PB-5/8"  
 - 0.018 Edge Tape  
 - Plywood 1/2" Wall Cleat  
 - Frosted Acrylic Cover  
 - LED Strip 2700K-3000K  
 - 2/AC - 2/USB - W/Switch Plug On

**COMMENTS:**  
 - Overall: 148"W x 5"D x 27 1/2"H  
 - Color: Wilsonart - D504-60 - Fossil Shale  
 Headboard Fabric - Per Scheme  
 - Note: Dimensional Tolerance +/- 1/16"

**TITLE:** AHB 8240XX H5U24N - 8250CRS - Queen HB + 24W Cntr Pnl

**REVISION DATE:**

NOTE: DESIGN AND DRAWINGS ARE PROPERTY OF DICKSON FURNITURE MANUFACTURERS LLC AND MAY NOT BE DUPLICATED OR REPRODUCED WITHOUT THE EXPRESS WRITTEN CONSENT OF DICKSON FURNITURE MANUFACTURERS LLC

REV  
**A**  
DIMENSIONS  
ARE IN  
INCHES

**DICKSON**  
FURNITURE MANUFACTURERS

SCALE: 1:18

SHEET 2 OF 4



# IMPORTANT INFORMATION

- X-218 AHB 8240XX H5U24N - 8250CRS - Queen HB + 24W Cntr Pnl -



Lift parts with at least 2 people

## \*RECOMMENDATIONS:

- Read instructions before assembling
- Keep area clean
- Do not drag the parts
- Do not forget to wear PPE

## \*PERSONAL PROTECTION EQUIPMENT (PPE)

- Hand Protection
- Eye Protection
- Waist Support belt

## PARTS:

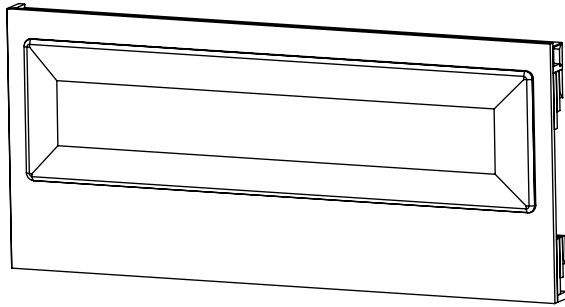

Left Headboard

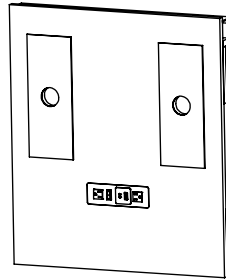

Center Panel

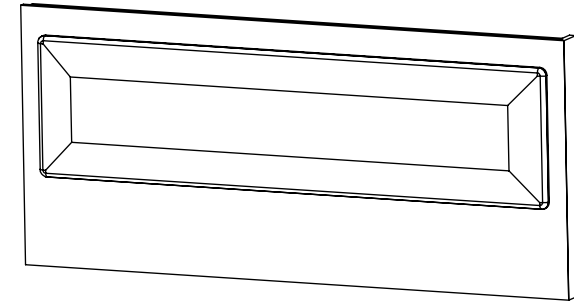

Right Headboard

## \*Tools:



Water level



Measuring Tape



Pencil



Drill

## \*Hardware:



Screw

# DICKSON

FURNITURE MANUFACTURERS

# STEP #1

# INSTALLATION INSTRUCTIONS

- X-218 AHB 8240XX H5U24N - 8250CRS - Queen HB + 24W Cntr Pnl -

Note: Assembly can be done with 2 people.

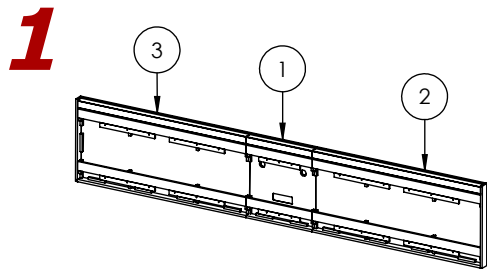

Unroll the power plug wires from the back on the Center Panel (1) and pass through it.

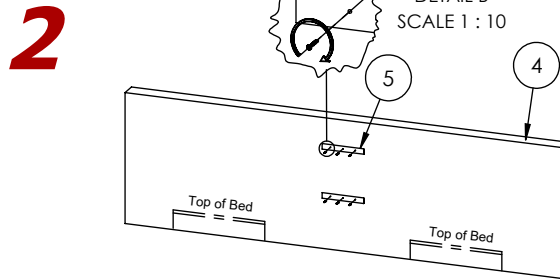

Center bed platform on Headboards wall (4) and mount Center French Wall Cleats (5) on Wall in the middle of both Bed Platforms. Screws go into studs.

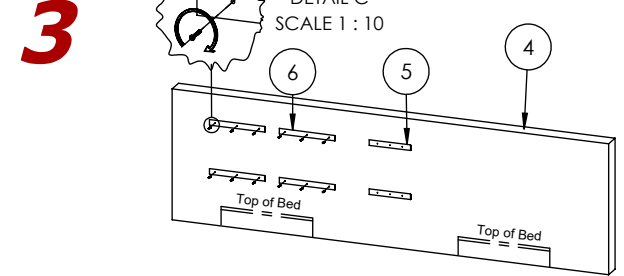

Mount Left French Wall Cleats (6) on Wall (4) on the left side of Center French Wall Cleats (5). Screws go into studs.

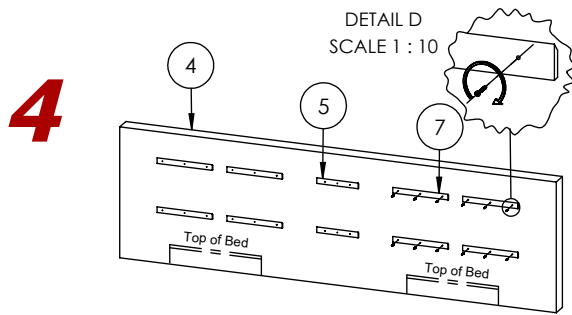

Mount Right French Wall Cleats (7) on Wall (4) on the right side of Center French Wall Cleats (5). Screws go into studs.

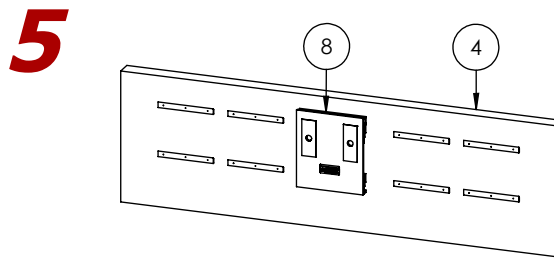

Lift Center Panel (8) higher than Center French Wall Cleats and slowly slide it down until it holds on Wall.

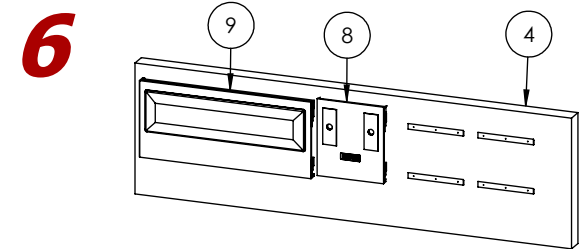

Lift Left Headboard (9) higher than Center French Wall Cleats and slowly slide it down until it holds on Wall.

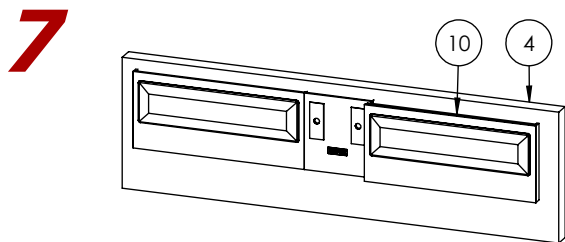

Lift Right Headboard (10) higher than Center French Wall Cleats and slowly slide it down until it holds on Wall.

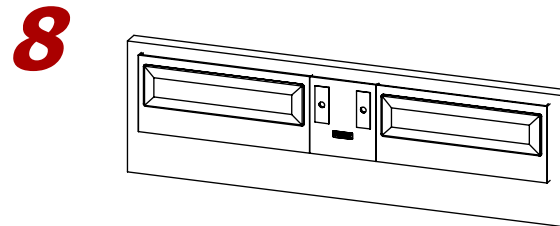

Completely assembled.  
Note: Led lights and no power strip provided, customer need to supply. Upholster panel is options include instruction accordingly.